

### Hardware Checklist

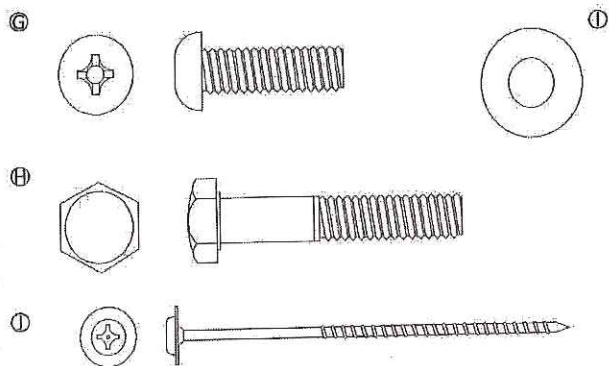

- Ⓒ (8) 3/4" Phillips Head Screws
- Ⓗ (5) 1 3/4" Hexagonal Bolts
- Ⓘ (5) Washers
- Ⓢ (2) 2 1/4" Square-head Screws

0.

Assemble the bed as close as possible to its final position in the room.

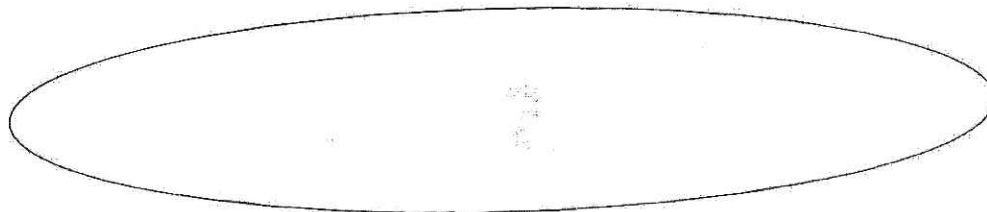
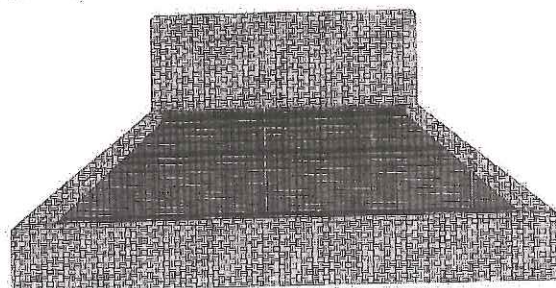

1.

Position the bed's headboard and position the bed's left-rail so that both the headboard's bolder and left-rail's holder are next to each other.

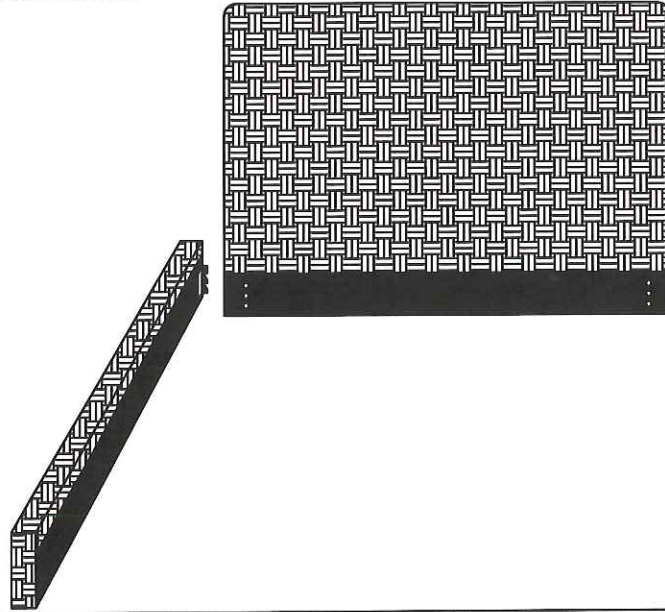

2.

Align and connect the side rail's holder to the headboard's bolts.

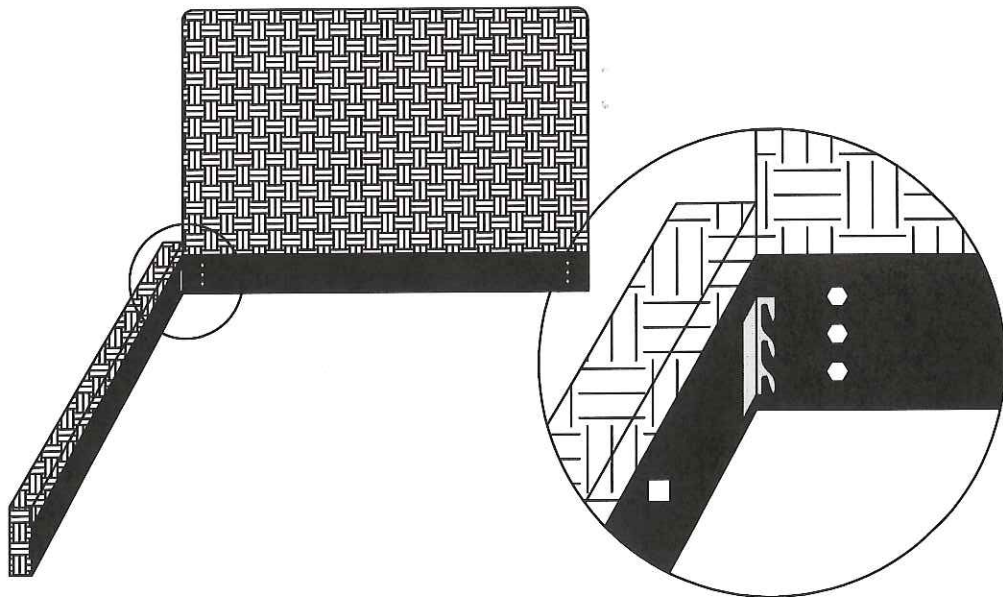

3.

Secure the left-rail's holder to the headboard's bolts by tightening the bolts.

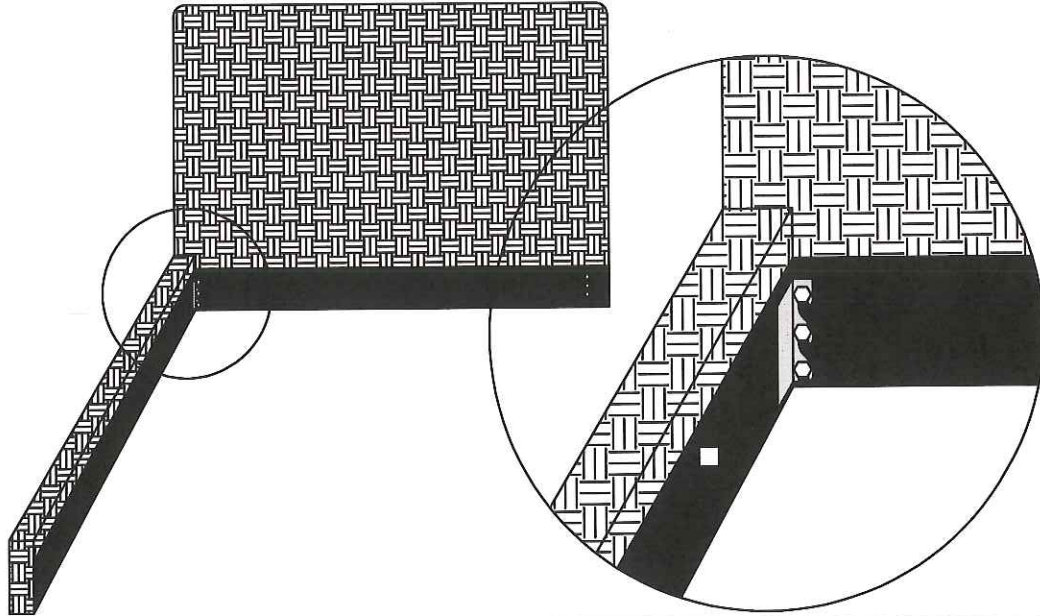

4.

Tools can be used to tighten bolts and ensure that side rail is firmly connected to the headboard.

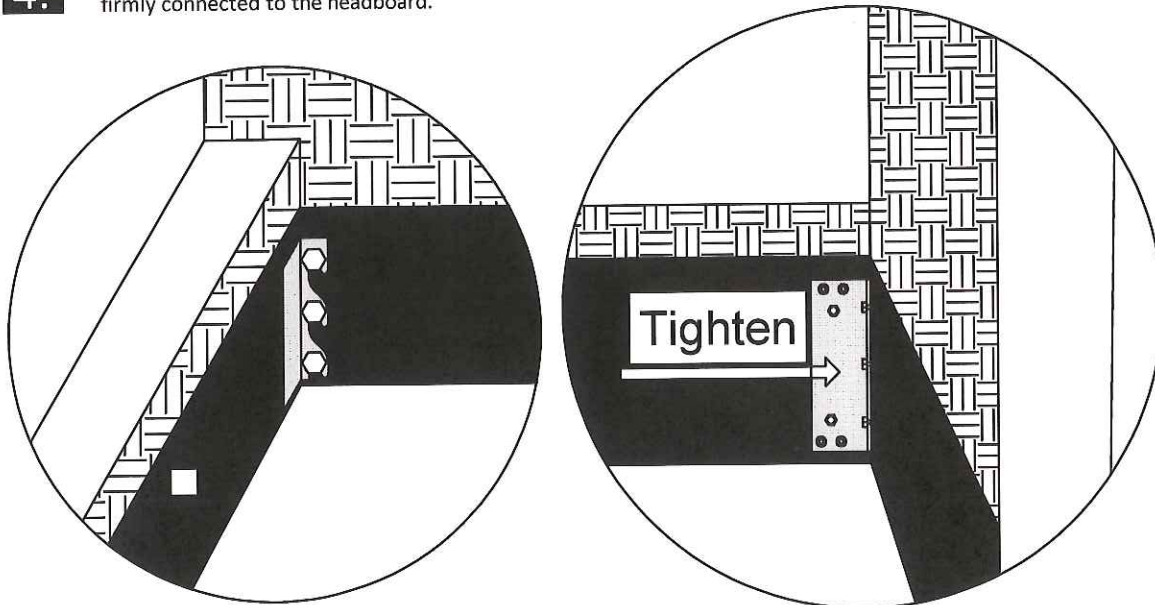

5.

Position the bed's headboard and position the bed's left-rail so that both the headboard's bolder and left-rail's holder are next to each other.

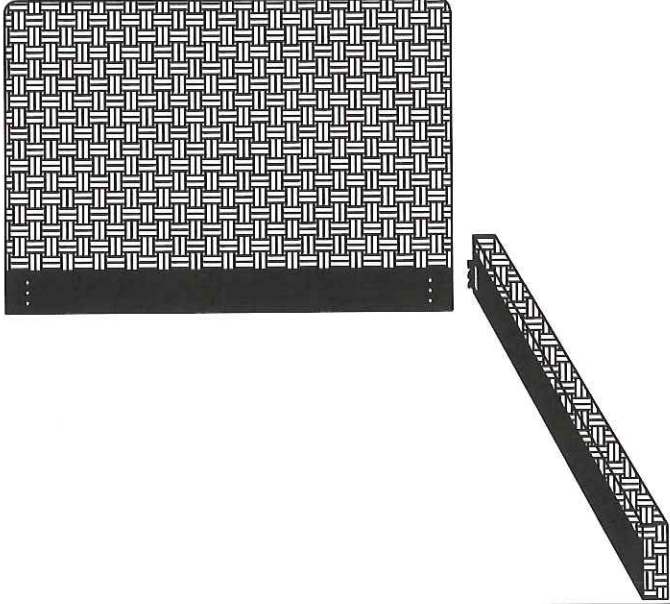

6.

Align and connect the side rail's holder to the headboard's bolts.

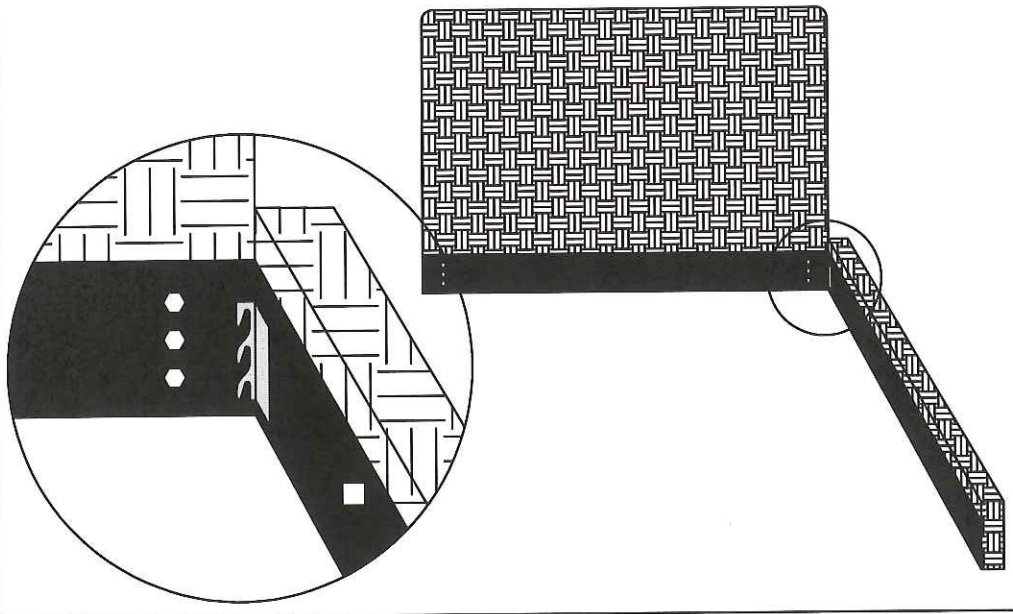

7.

Secure the left-rail's holder to the headboard's bolts by tightening the bolts.

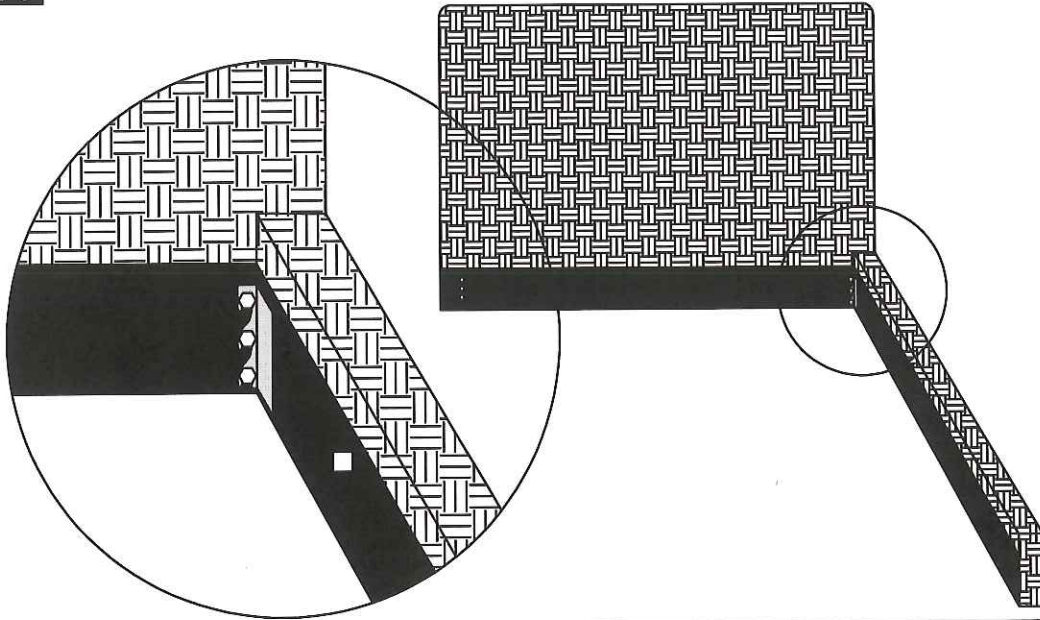

8.

Tools can be used to tighten bolts and ensure that side rail is firmly connected to the headboard.

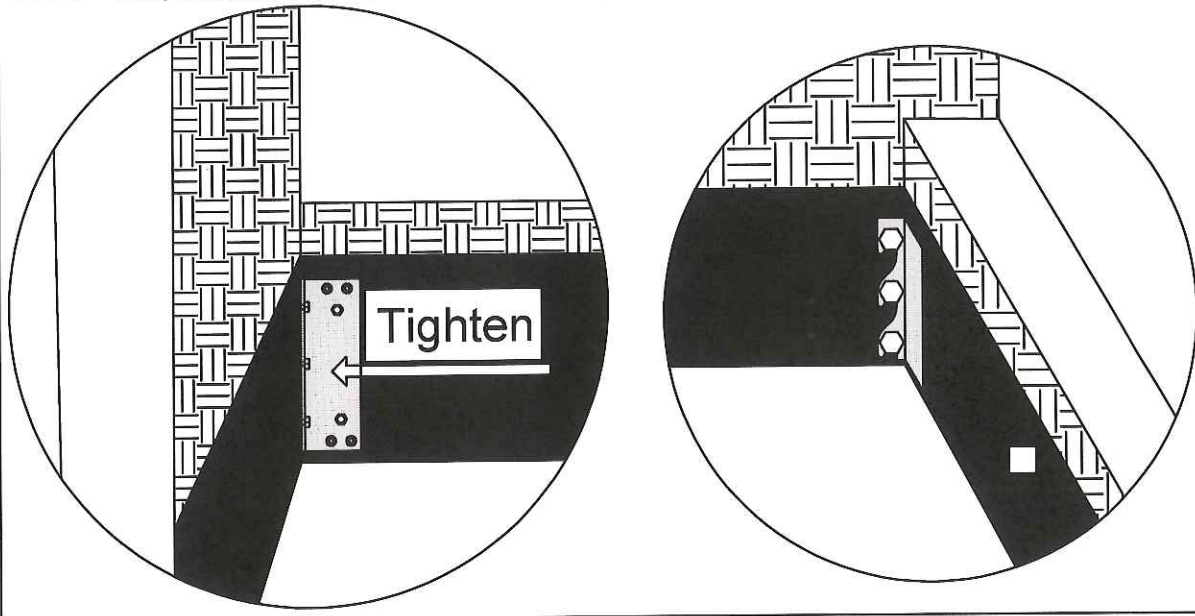

9.

Insert a wooden slat into the first bracket, identifiable with added metal braces.

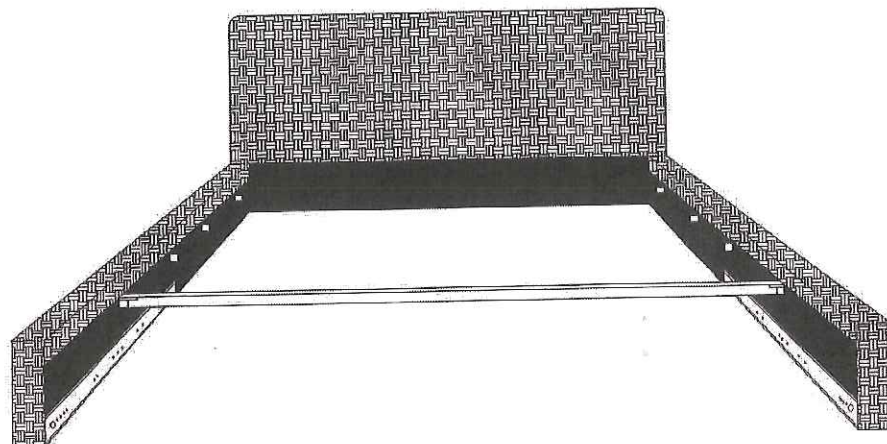

10.

Insert two square-headed screws into the metal braces of the first slots, securing the first slat.

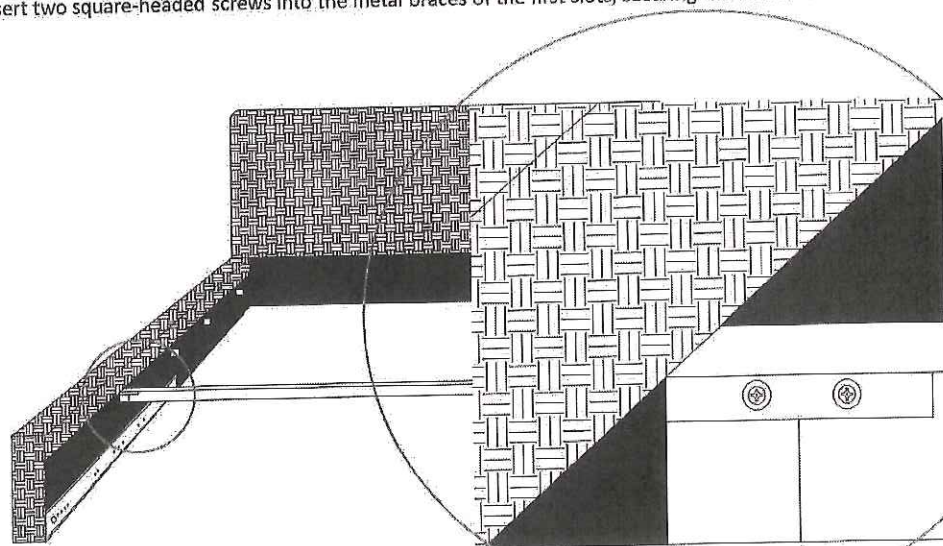

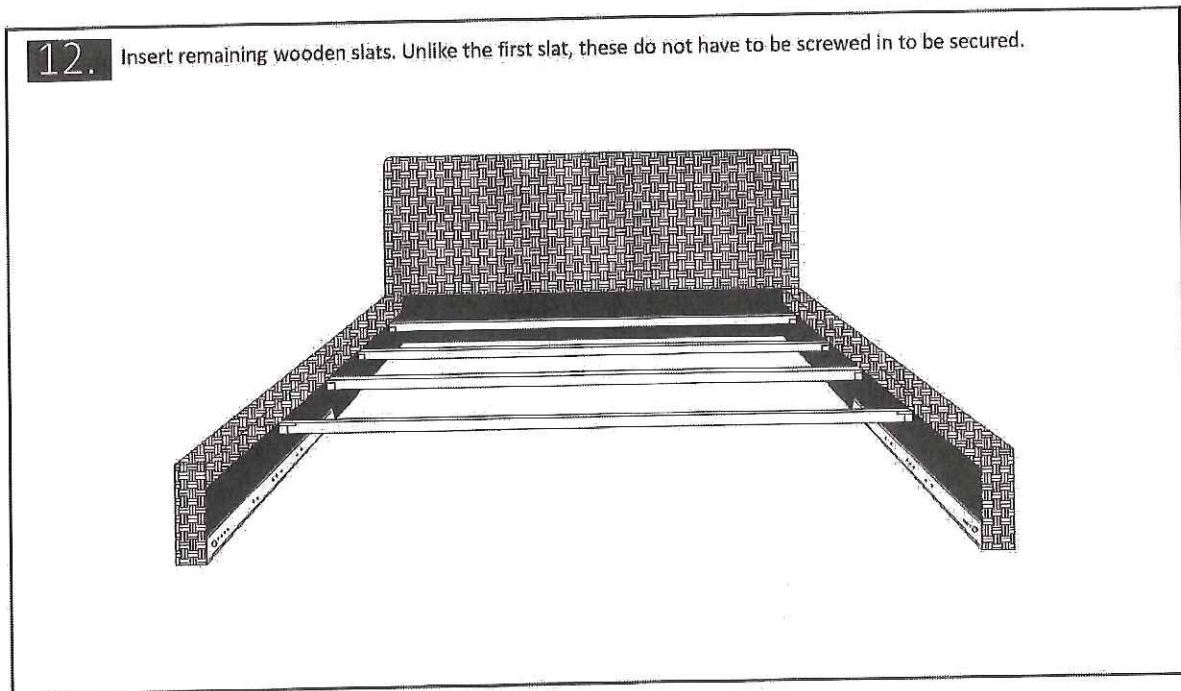
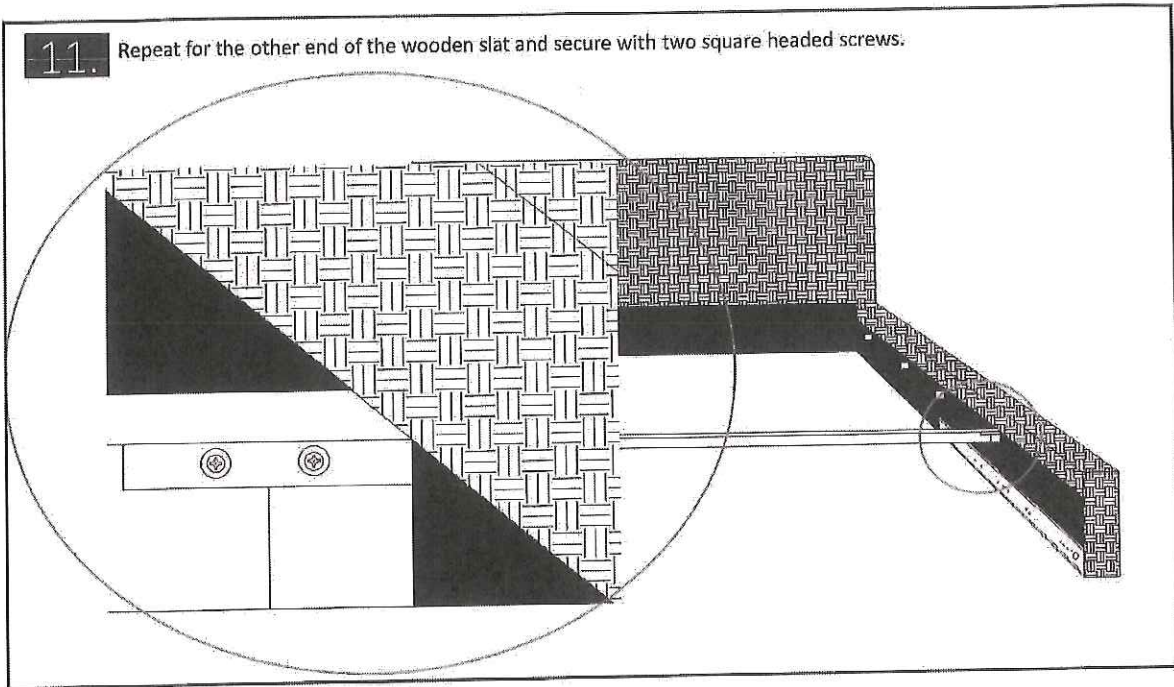



13. Position the bed's drawer between both bed side rails. The face of the drawer is identifiable with the four holes on its front.

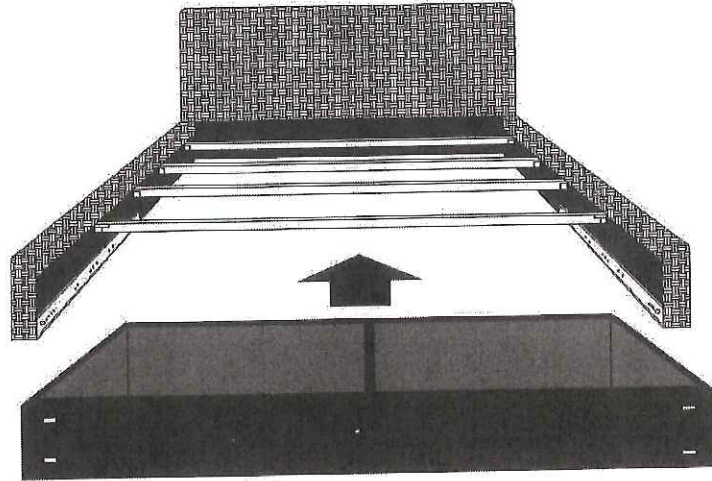

14. Extend the drawer slides and adjust the depth of the drawer to make it flush with their full extension on both sides of the drawer.

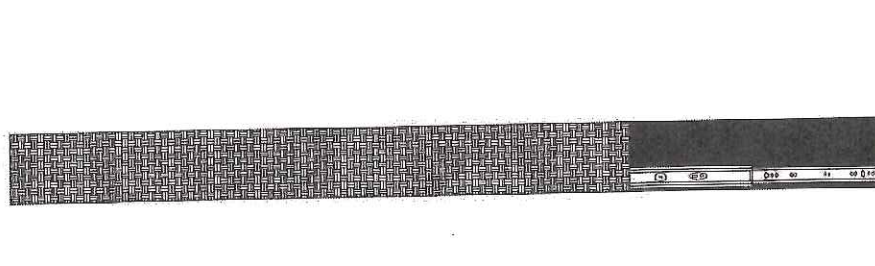

**15.** Insert (4) Phillips head bolts into the sides of the drawer's threaded holes.

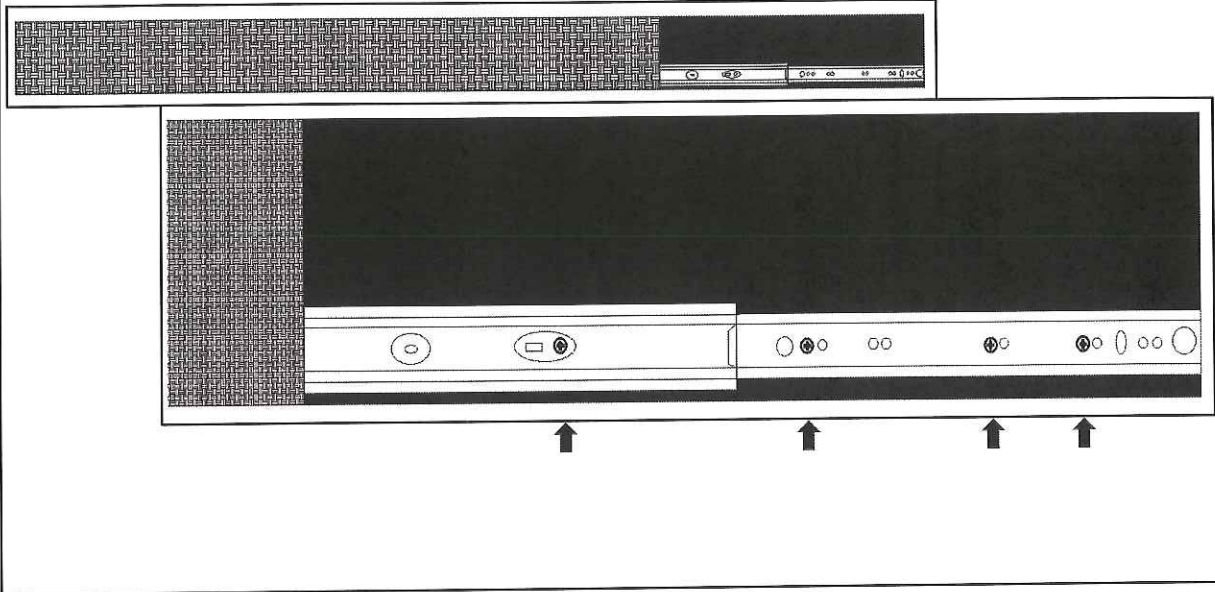

**16.** Gather the foot rail of the bed, the (5) bolts, and (5) washers. The back of the footboard should have 5 holes for bolt insertion.

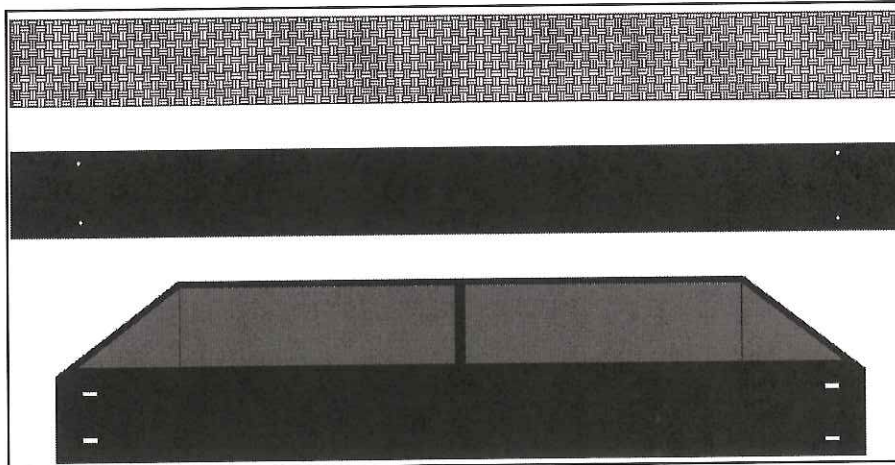

- 17.** Align the foot rail holes with those on the drawer. From the inside of the drawer, bolt in with washers.

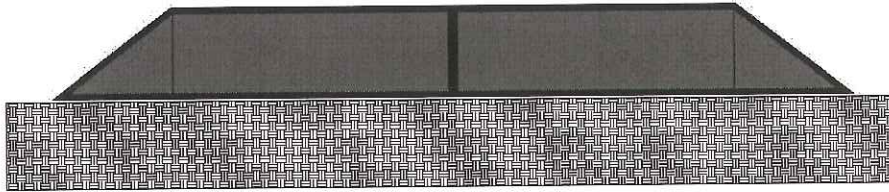

- 18.** Position both Bunkie boards to lay atop the exposed wooden slats.

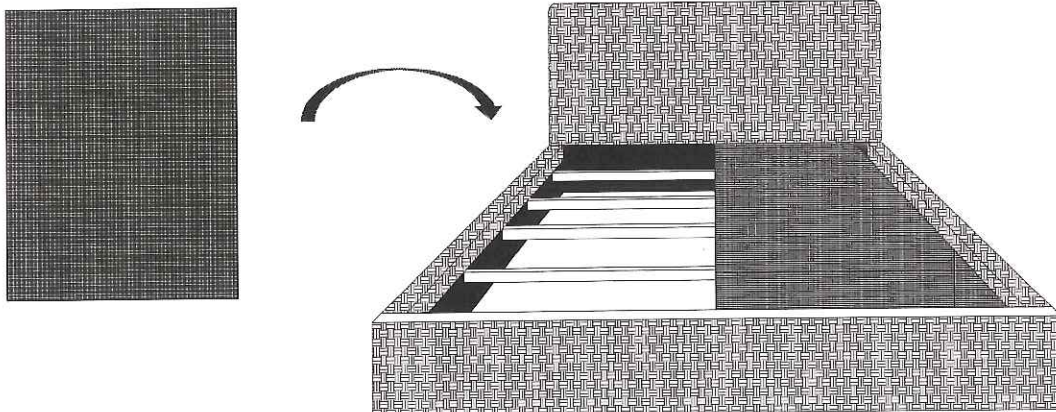

19. Enjoy your newly assembled bed!

